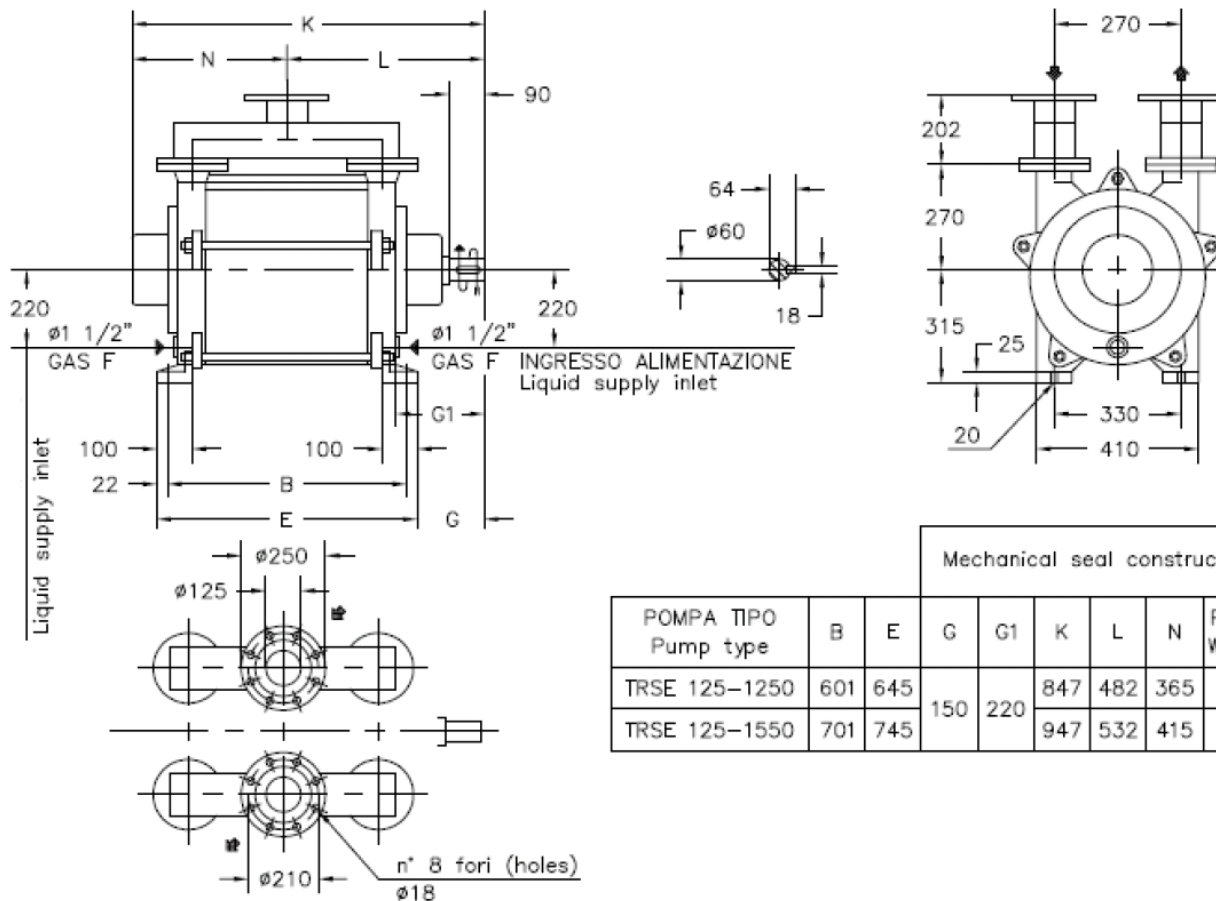
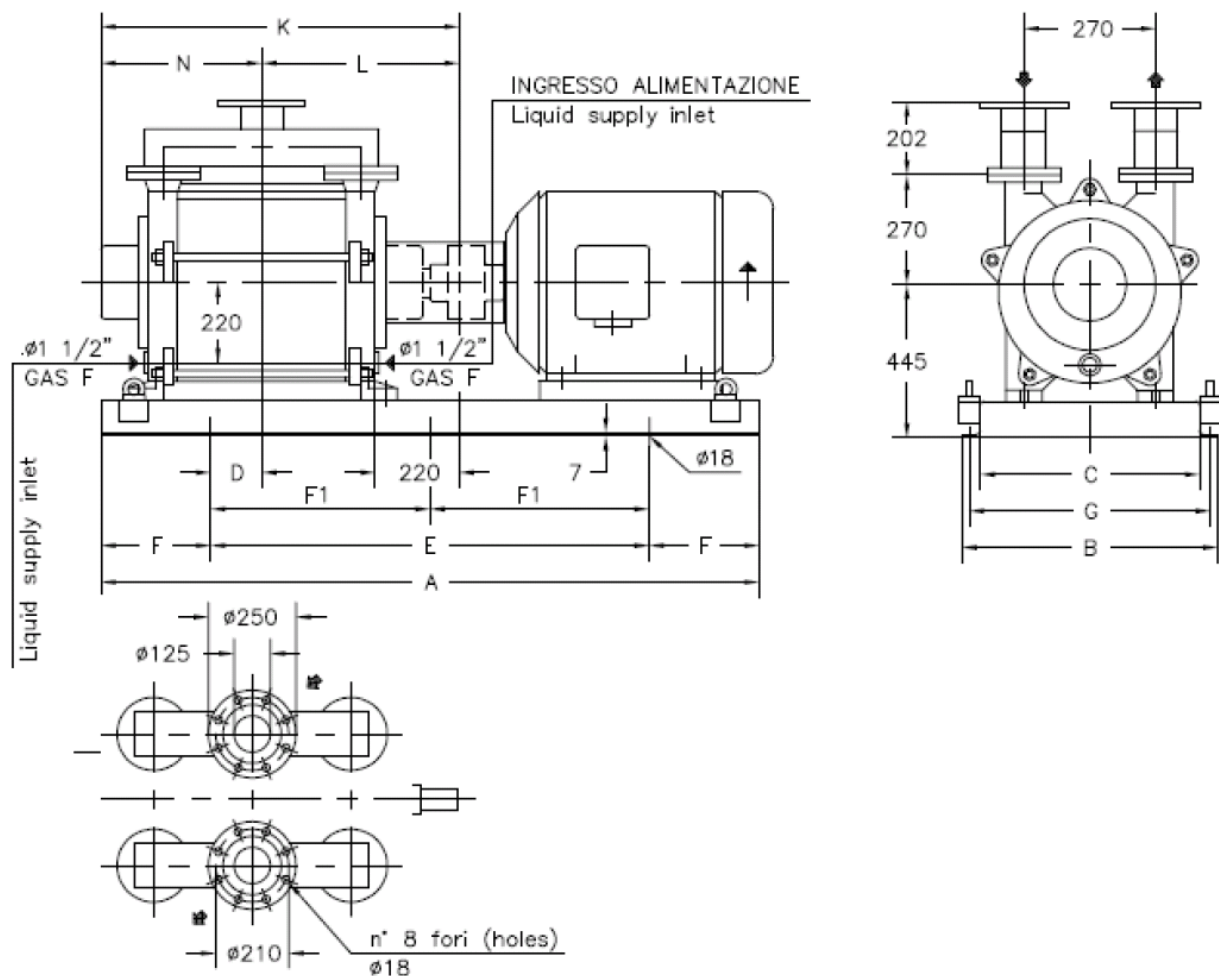

Вакуумный насос TRSE 125-1550
Исполнение без рамы и электродвигателя.

Исполнение на раме.

POMPA TIPO Pump type	MOTORE A 6 POLI 6 Poles Motor UNEL-MEC-B3		POMPA Pump									PESO Weight ①	
	Типо/Type	KW	A	B	C	D	E	F	F1	G	L		N
TRSE 125-1250/C	225 M	30	1700	590	450	220	1100	300	-	540	482	365	599
	250 M	37	1800	640	500		1400	200	700	590			596
	280 S	45				320							608
	280 M	55											
TRSE 125-1550/C	280 S	45	2150	680	540	360	1600	275	800	630	532	415	634
	280 M	55											
	315 S	75											

Вес указан без электродвигателя.