

Вакуумный насос TRHA 150-2000
Исполнение без рамы и электродвигателя.

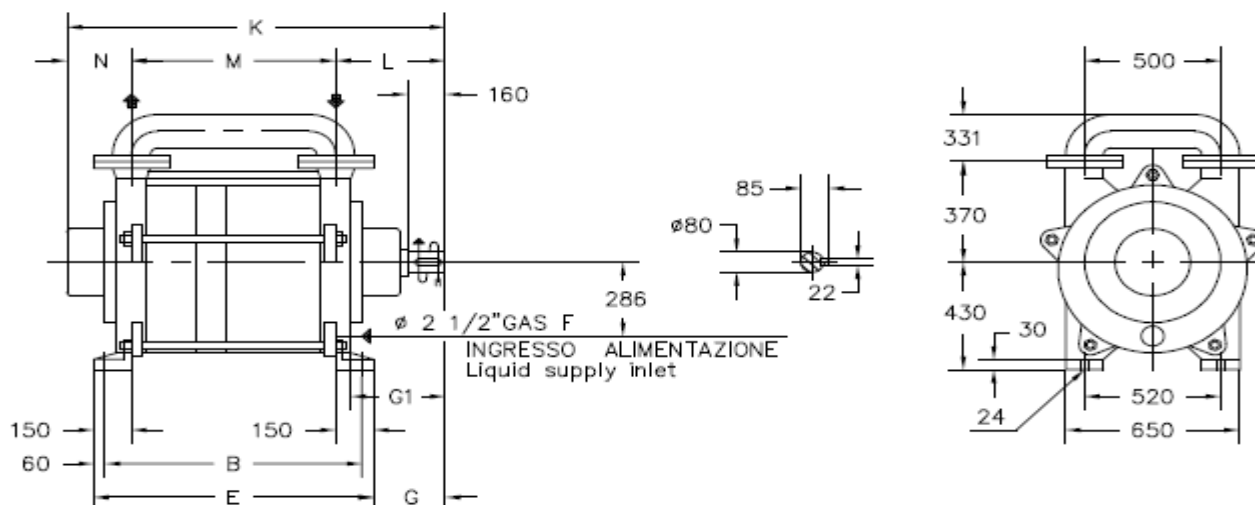

POMPA TIPO Pump type	B	E	M	G	G1	K	L	N	PESO Weight
TRHA 150-2000	960	1080	830			1660			1330
TRHA 150-2600	1110	1230	980	372	402	1810	497	333	1480
TRHA 150-3100	1210	1330	1080			1910			1630

Исполнение на раме.

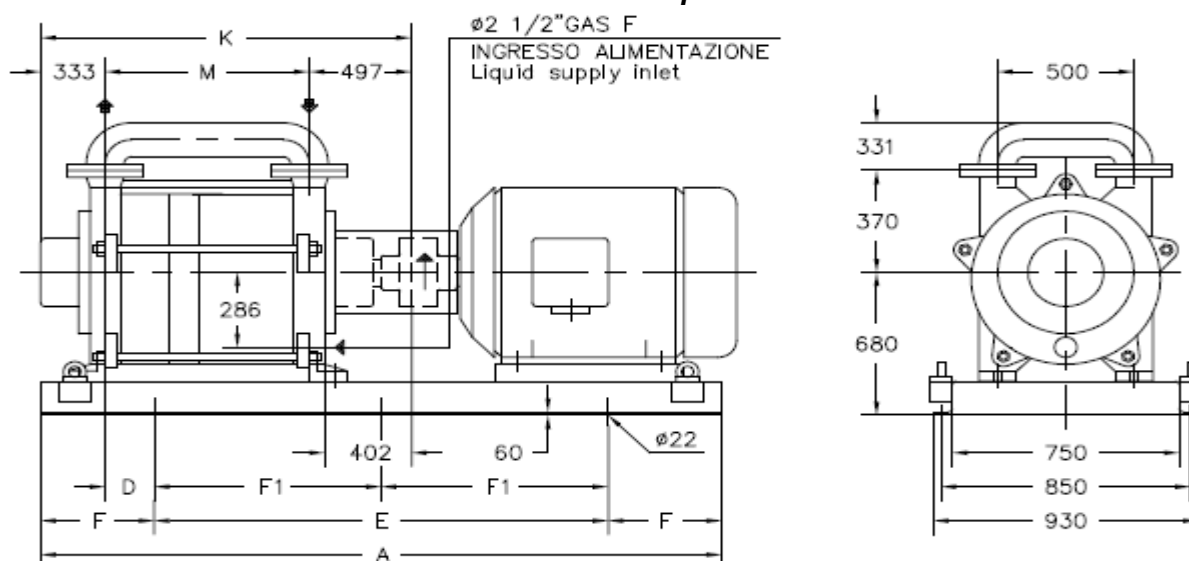

POMPA TIPO Pump type	MOTORE A 8 POLI 8 Poles Motor UNEL-MEC-B3		BASE Base-plate N°	POMPA Pump							PESO Weight ①
	TIPO/Type	KW		A	D	E	F	F1	K	M	
TRHA 150-2000/C	315 MA	75	60F	2400	145	1800	300	900	1660	830	1805
	315 MB	90			1945						
TRHA 150-2600/C	315 MB	90	61F	2800	110	1900	450	950	1810	980	2095
	355 S	110			225						
TRHA 150-3100/C	355 S	110			250				1910	1080	2245
	355 MB	160			315						

Вес указан без электродвигателя.